



Single Storey Extensions

Warmer Living Collection

Faster Warmer Smarter

Warmer Roof, the leading UK manufacturer of replacement conservatory roofs, have now added the stunning Single Storey Extension Kit's to our range. Using our existing innovative pod system, we have created the most stunning, beautifully crafted extensions that will transform and expand any home living space.

A Warmer Roof home extension kit can take all the worry and much of the effort out of any new home extension project. What is more, our competitive pricing, rapid manufacturing and delivery turnaround mean that your customers will enjoy a brighter, more spacious home quicker and cheaper than a traditional extension.

P1 Single Storey Extensions

A few reasons why homeowners love Warmer Roof Extensions

- ✓ Save money on heating bills
- ✓ Add significant value to your home
- ✓ Rapid build time



DESIGN FLEXIBILITY

Choose either a pitched tiled roof or flat EPDM rubber roof. Almost any extension design is achievable.



Warmer Living Collection **P2**



> To the trade

- * **3 week turnaround time**
- * **Free Delivery Service**

P3 Single Storey Extensions

Assembly Drawings

Supplied with all Extension Kits

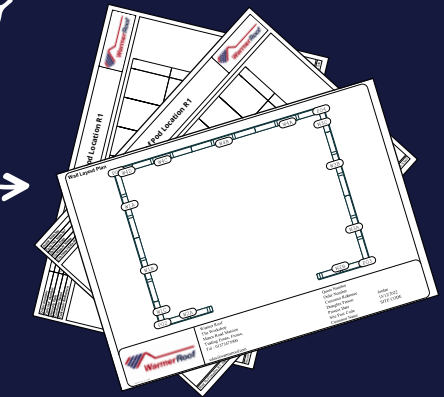

Complete Kit One Supplier

- ✓ **Durabase System**
Durable steel base system with a stylish brick slip border complete with 100mm floor insulation and 22mm chipboard flooring.
- ✓ **160mm Wall structure**
A 6x2" structural grade timber wall section, covered with a 15mm OSB outer skin.
- ✓ **Roof System**
Choose either a Pitched Roof or Flat Roof System for your extension made from structural grade timber with a 15mm OSB outer skin.
- ✓ **Premium Insulation**
125mm multifoil honeycomb insulation pre fitted into all wall and roof sections for maximum thermal efficiency.
- ✓ **External Cladding**
Innovative exterior PVC cladding range that features an authentic embossed wood effect finish complete with all finishing trims.
- ✓ **Wall Finish Kit**
Waterproof breather membrane, treated timber battens, DPC, starter trims and fixings.
- ✓ **Insulated Plasterboard (PIR)**
52.5mm Insulated Plasterboard for a smooth internal finish ready to be skimmed and decorated.
- ✓ **Roof Tiles or EPDM Rubber**
Choose from our range of synthetic slate or Shingle tiles. Firestone Rubber provided with all Flat Roofs.
- ✓ **Soffit and Fascia Board**
We have a range of soffit and fascia colour options available to complement your cladding choice.
- ✓ **Windows & Doors**
We have a range of contemporary UPVC and aluminium Patio, French or Bi-Fold options in a range of colours. Full height, pocket, and corner return windows are also available.
- ✓ **Rainwater Goods**
Stylish double Ogee gutter system.
- ✓ **Extra's**
Keylite Roof Windows, Fixed Roof Glazing Panels, Window Blinds, and much more.....

Warmer Living Collection **P4**

Why choose a Warmer Roof Extension over traditional systems?

Quick Installation

Warmer Roof Extensions are much quicker than traditional methods, reducing the amount machinery needed, making you huge savings.

Less mess, less waste

Your Extension arrives in kit form to ensure a stress free installation. This means far less excavation work and waste material to dispose of compared to other methods of construction.

Guarantee

All Extensions come with a **25-year guarantee** to give you peace of mind and confidence in the product provided.

P5 Single Storey Extensions

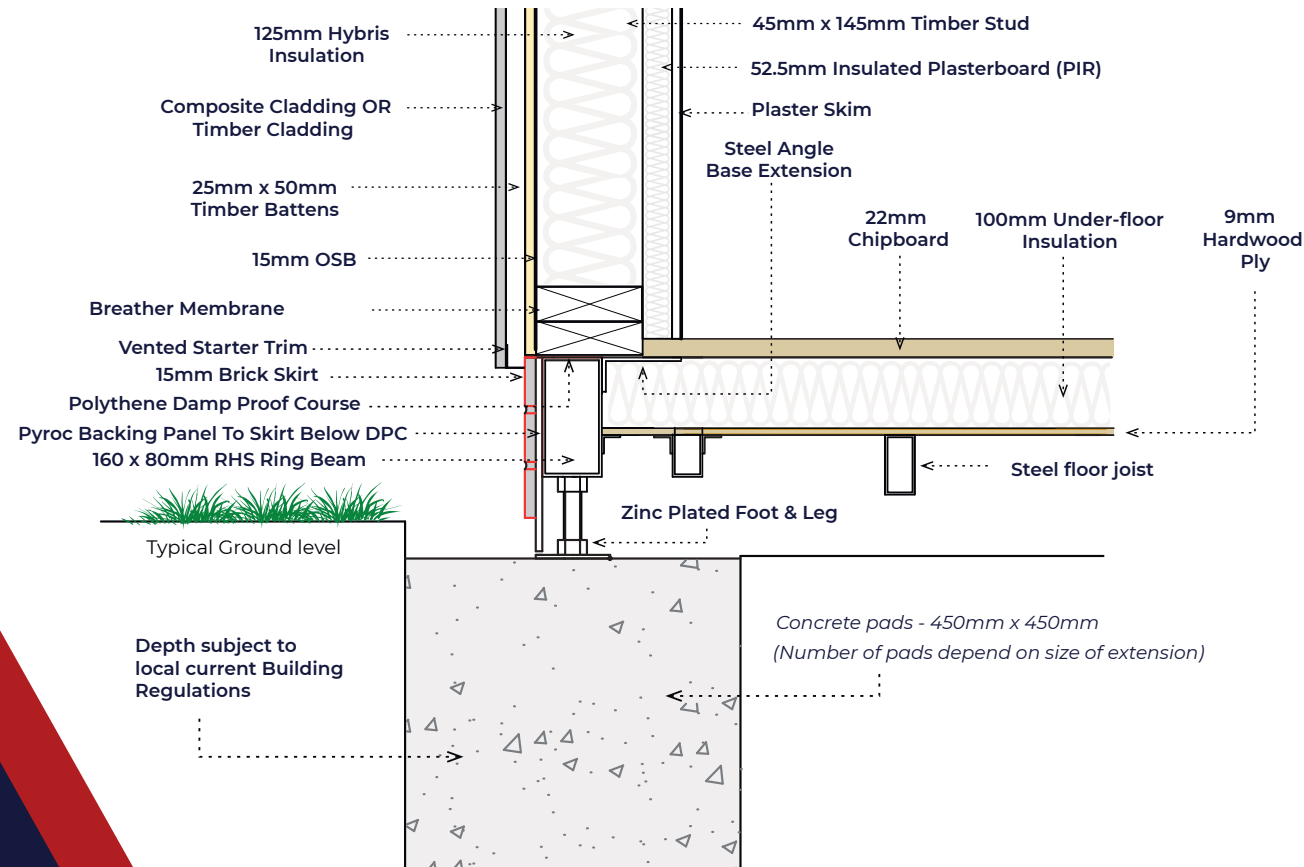

What is a WarmerBase?

A durable steel system, all delivered in kit form to ensure a smooth installation with no large amounts of concrete or building materials needed, unlike traditional methods. The steel frame is placed on concrete pads and is fully insulated for maximum thermal efficiency. The Durabase System arrives in sections for easy handling, so even the narrowest sites with difficult access are not a problem.

Durabase Assembly Drawings

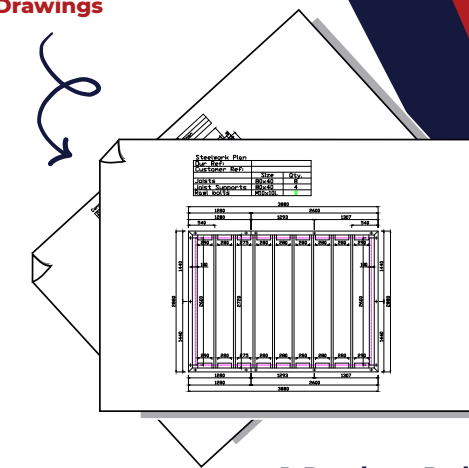

1. Durabase Pad Plan

2. Durabase Steelwork & Skirt Plan



U-Value of **0.18** Wm²K

Building Control Approved

Your Warmer Base has been tested and certified by JHAJ Building Control Ltd, an accredited national building control approvals agency.



Over 40 brick choices...

Warmer Living Collection **P6**



Roof Styles

Pitched and flat roof options available, all with external soffit detail as standard.

Your Pre-Approved System



U-Value of
0.18 Wm²K



U-Value of
0.15 Wm²K



U-Value of
0.16 Wm²K

Why choose a Warmer Roof Extension ?

- Premium Materials**
 Our timber can grow for up to 120 years before harvesting. It's this slow growth that gives you distinctive durability and a premium finish.
- Versatile**
 Timber can be easily modified on site unlike aluminium. This can speed up the installation process should site conditions dictate changes in the installation.
- Natural Insulator**
 Timber is a natural insulator. As a result, timber frame buildings are more thermally-efficient and require less energy, making them cheaper, easier (and greener) to heat.
- Thermal Performance**
 Exceptional thermal performance helps to keep your extension cool during the summer and retains heat during the winter.
- Building Control Approved**
 The Warmer Roof Extension has been tested and certified by JHAI Building Control Ltd, an accredited national building control approvals agency.
- We are Eco-friendly**
 No construction material offers more environmental benefits than timber, and all of our timber is sourced from responsible companies with sustainable forest regeneration programmes.
- Customisable**
 Make it your own with a choice of external and internal finishes such as soffit and pelmet details, roof glazing and tile options.
- Robust Structure**
 A solid timber structure, supported with 150mm corner posts and covered with a 15mm OSB outer skin for extreme rigidity and strength.
- Frame Configuration**
 All window and door opening configurations are bespoke and customisable. Add as little or as much glass in your extension as you like. Give us the frame sizes and positioning and we'll do the rest.





Pitched Roof Designs Options

Thanks to our unique pod system and innovative design, the Warmer Roof can be adapted to all roof styles. Our timber frame allows us to create completely bespoke designs suited to the space you have available for your Extension.



VAULTED CEILINGS

Thanks to our structurally engineered steel corner braces which are completely concealed, you are able to have a clean vaulted ceiling without the need of Trusses, Tie bars / Tie wires on any pitched roof up to 5 x 5m.

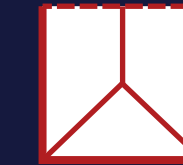

Edwardian

A simple but effective shape made up of three sides sloping towards ridge.



Double Edwardian with box gutter

Double sided Edwardian with aluminium box gutter.



Lean-to

A simple, mono pitched roof offers clean lines. Perfect for adding large opening vents.



Hipped lean-to

Same shape as a lean-to with the addition of two hips creating two extra sloping sides.

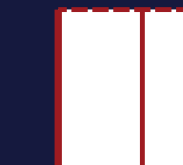

Gable

A contemporary look with the option of a glass gable frame to front to maximise natural light.

Stylish Roof Exteriors

Gutter colour options



* Request your Sample Swatch



Fascia colour options



Slate Tiles



Shingle Tiles



Slate options manufactured from recyclable blend of **limestone and polypropylene** mimic the appearance of **genuine slate** with **textured surface and riven edges**.

Shingle options are manufactured from **galvanised steel sheet** with a **stone-coated finish**. These are a **practical, economical and sustainable** tile option for your roof.

 **Guarantee**
40 Year guarantee provided with all tiles.



Our unique, pre-fabricated **modular pod system** ensures a speedy installation with minimal disruption to your home and garden.



Guarantee
25 Year guarantee provided with all Warmer Roof Extensions.

Let there be light

With unrivalled looks and thermal performance, the Flat Roof System combined with a glass lantern will bring stylish ambience to your home whilst maximising natural light and provide you with a bright and airy living space.

Our timber pod system, filled with 125mm of honeycomb insulation offers exceptional thermal performance, covered externally with Firestone EPDM rubber for extreme durability and complemented with a contemporary external soffit detail, perfect for adding spot lights.

* All Firestone EPDM Rubber comes with a **25 year guarantee**

* **70mm timber upstand** supplied as standard

Design will vary dependent on size. All Roof Lanterns are made-to-order.

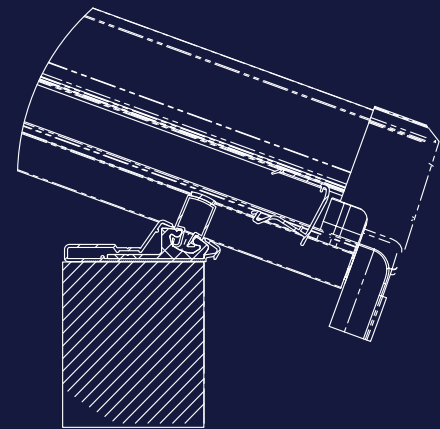
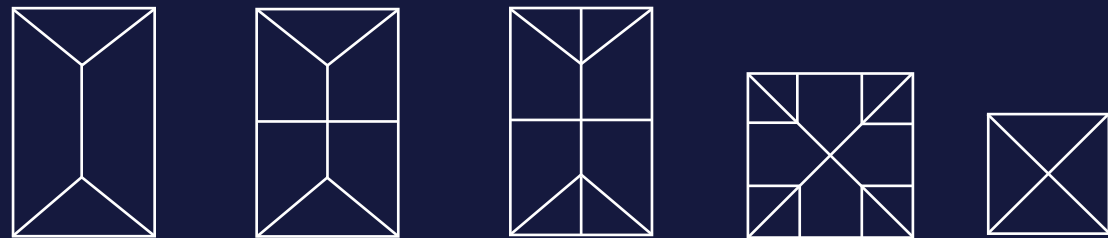

Stylish External Cladding



Easy to install

All Freefoam cladding products are easy to fit. Both the standard PVC-U and Aluminium range of fitting trims ensure every installation is straightforward, designed to create a neat and professional finish.

Very low maintenance

PVC is a very stable material. Cladding products made from PVC do not require repainting or regular maintenance. A simple wipe-down with a damp cloth is all that's required to keep Freefoam cladding products looking their best. This offers a major long-term advantage over wood cladding saving time and money.

Versatile

Freefoam cladding can be used on all types of exteriors including brick, masonry and concrete. Suitable for a wide variety of projects and situations, offering an attractive facade for both traditional and contemporary projects.

Cut heating costs with exterior cladding

With heating costs always a concern, fitting exterior wall cladding can provide the ideal solution to insulate your home. When installed with generic insulation materials, The Building Research Establishment's (BRE) 'Green Guide to Specification' has given PVC cladding an A+ rating.



Guarantee
10 Year guarantee provided on all Cladding.

External Finish Options

Want to use a real wood cladding or even a rendered finish? Your Extension can be supplied without any cladding leaving you to customise externally.

Create your dream extension

1

Choose your base system

Your Warmer Roof Extension can be supplied with a Durabase System or alternatively retrofit onto concrete foundations. All foundations must comply with JHA1 Building Regulations.

2

Think about size

Think about the space and budget you have available. Warmer Roof will manufacture your extension to almost any size.

3

Windows and doors

We have a wide range of quality windows and doors that can be configured to suit your Extension. We even offer high performing aluminium bi-folding doors to help open up your space.

4

Choose your roof system

Pitched and flat roof options available, all with external soffit detail as standard.

5

Think style and colours

Which cladding colour will match my roof tiles? Brick Slips to match the house bricks? The choices are yours.

6

Check out all the optional upgrades

Opening roof windows or fixed glass panels can be added to the Pitched Roof System to maximise the natural light coming into your extension. Ask a member of staff to see what added features are available for you.

Need advise on the best options for you?

Speak to your local installer who will advise on the best options to suit your budget and personal taste.

Testing & Approvals



Building Control approval made easy with jhai System approval

Warmer Roof and JHAI have formed a formidable relationship and are now working together to ensure a smooth, hassle-free building control approval process for all Warmer Roof customers when taking advantage of the System Approval process.

Your Warmer Roof Extension has been independently tested and certified to gain System Approval Certification from JHAI, an accredited national building control approvals agency. These tests involve detailed analysis and verification of the roof system from independently sourced structural calculations, along with further assessment checks on thermal performance and condensation risk analysis.



P23 Single Storey Extensions

Performance

The following calculations have been carried out by an independent Insulation Specification Specialist to achieve a 0.15 Wm²K for Pitched Roofs, 0.16 Wm²K for Walls and 0.13 Wm²K for Flat Roofs

The calculations also undertook a Condensation Risk Analysis and further assessments that calculate the predicted dewpoint temperature. The results show there is no risk of condensation / moisture build up within the roof or walls. These results are paramount to ensuring no gradual degradation of the construction materials or chances of mould growth.



Warranty

When making an investment to your home, it is vitally important you can trust the product you are purchasing. With a Warmer Roof Extension you will receive a tried and tested system that is fully approved.

25 Year manufacturing warranty.
40 year tile manufacturers warranty .



Think before you buy

Does the extension you are investing in have all the relevant documentation to back up the Condensation Risk Analysis and U-Value Specification? Warmer Roofs timber construction coupled with the very best roofing insulation available means Warmer Roof passes with flying colours.

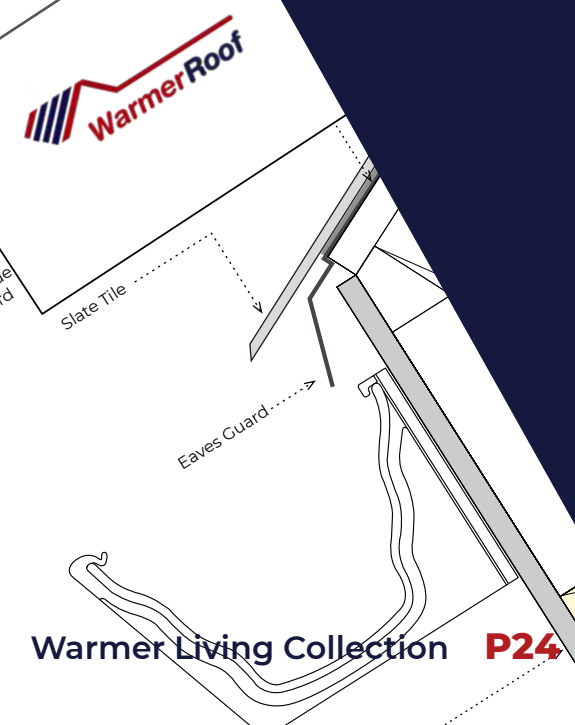

Warmer Living Collection **P24**



Your Questions Answered

What will the temperature be like inside my Warmer Roof Extension?

Due to the high performing multi-layer insulation, your Warmer Roof Extension will retain heat during the winter and be cool during the summer, saving you money on energy bills.

Will my new roof be strong enough to stand on to clean house windows?

Yes, your Warmer Roof is strong enough to stand on but we advise on all health and safety procedures being carried out prior to doing so.

Can I make the appearance of my new Warmer Roof Extension blend in with my house?

Absolutely, you can customise your Extension with a range of tile options, fascia, soffits and brick base borders to match the colours of your house. You can even choose a cladding that will complement the colours in your garden.

Do I need Building Control Approval?

Generally Building Control is required but it is wise to consult with your local council Building Control department as Building Control opinion can vary from council to council. Warmer Roof has full JHAI Building Control accreditation so this makes Building Control applications less complicated as an approved system is being used.

Will my new extension eliminate external noise from inside.

Your Warmer Roof Extension will substantially reduce external noise especially as the roof and wall insulation itself has acoustic performance properties. This considerable noise reduction will allow you to be more relaxed especially during inclement weather.

Do I need planning permission?

Not in most cases under permitted development rights however always check with your local planning authority for guidelines.

Can I use a new or existing concrete base?

Yes, your Warmer Roof Extension can be retrofitted onto a concrete base however always check with JHAI for approval as your base must comply with current building regulations.

Warmer Roof Ltd

warmerroof.com

The Workshop, Manor Road
Marston Trading Estate, Frome, Somerset
BA11 4BN

T : 01373 473 900

E : sales@warmerroof.com

